

STANDARD SERIES MONOCHROMATORS

Models 9010, 9055, 9057

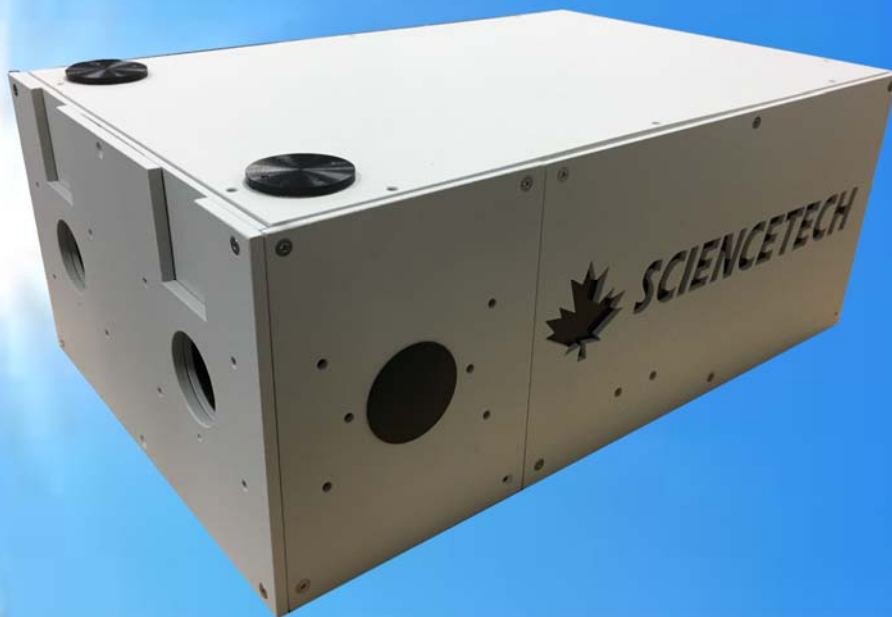

Features

- Highly customizable modular design
- Two configurable input and output ports
- Interchangeable turret design to allow more than three grating options*
- Configurable turret and grating options
- USB2.0 communication
- Fully integrated software and development libraries available
- Full line of input and output accessories

* Model 9055 and 9057

Applications

- Tunable monochromatic light source
- Spectroscopic systems:
 - Emission and source characterization
 - Absorbance, transmittance and reflectance measurement
 - High dispersion or high power density spectral illumination system
 - Electrochemical spectroscopy
 - Fluorescence spectroscopy
 - Scanning spectrophotometry
 - Raman spectroscopy

1450 Global Drive, London, Ontario Canada, N6N 1R3
Phone: 519 644 0135 / Fax: 519 644 0136
Email: sales@sciencetech-inc.com
www.sciencetech-inc.com



STANDARD SERIES MONOCHROMATORS

I. Overview

The Sciencetech standard series monochromators offer a flexible and customizable choice of monochromator with the full functionality afforded by motorized wavelength control and a multiple grating turret.

The design features asymmetric Czerny-Turner optical layout, using up to 3 plane-ruled gratings with an f/3.5 aperture. An adjustable slit is included for the input port. Additional slit options and several accessories are available.

For applications requiring better signal to noise, reduced stray light and better resolution than the standard model, a double monochromator (9055DX) in double additive mode is available. For applications requiring a tunable bandpass or notch filter light source, the double subtractive mode is an ideal choice.

2. Specifications

Model	9010	9010F	9055	9055F	9055DX	9057	9057F
Input Focal Length (mm)	200	200	200	200	200 × 2	457	457
Output Focal Length (mm)	200	200	250	250	250 × 2	457	457
Wavelength Selection	Manual or motorized	Manual or motorized	Motorized	Motorized	Motorized	Motorized	Motorized
Communication	USB 2.0	USB 2.0	USB 2.0	USB 2.0	USB 2.0	USB 2.0	USB 2.0
Readout Mechanics	Sine drive	Sine drive	Direct drive stepping motor	Direct drive stepping motor	Direct drive stepping motor	Direct drive stepping motor	Direct drive stepping motor
Spectral Range* (with 1200/mm grating)	0-1050 nm	0-1050 nm	0-1350 nm	0-1350 nm	0-1350 nm	0-1450 nm	0-1450 nm
Aperture	f/3.5	f/2.6	f/3.5	f/2.5	f/3.5	f/8	f/5.9
Maximum Grating Size (mm × mm)	50 × 50	64 × 64	50 × 50	64 × 64	50 × 50	50 × 50	64 × 64
Number of Gratings	2	2	3	2	3	3	2
Optical Resolution* (nm)	0.4	1	0.2	0.4	0.09	0.1	0.2
Stray Light**	2×10^{-6}	2×10^{-6}	4×10^{-5}	4×10^{-5}	1×10^{-7}	3×10^{-5}	3×10^{-5}
Dispersion* (nm/mm)	4	4	4	4	1.7	1.79	1.79
Wavelength Accuracy (± nm)	0.2	0.2	0.2	0.2	0.2	0.04	0.04
Wavelength Reproducibility (±nm)	0.1	0.1	0.03	0.03	0.05	0.03	0.03
Flat Field Size (mm)	N/A	N/A	25	25	25	25	25
Flat Field Angle (°)	N/A	N/A	-1.69	-1.69	Call	-1.4	-1.4
Optical Axis Height (mm)	76.2	76.2	76.2	86.4	76.2	76.2	76.2
Dimensions (mm)	255 × 290 × 140	255 × 290 × 140	395 × 262 × 130	395 × 262 × 130	800 × 525 × 260	605 × 265 × 130	605 × 265 × 130
Weight (kg)	6	6	7.5	10	20	9	9

* With a 1200/mm grating and minimum slit height , ranges vary with grating groove density.
 ** Stray light values are with holographic gratings, ruled gratings produce worse stray light

[Browse standard series monochromators on the Sciencetech website!](#)



STANDARD SERIES MONOCHROMATORS

3. Configuration

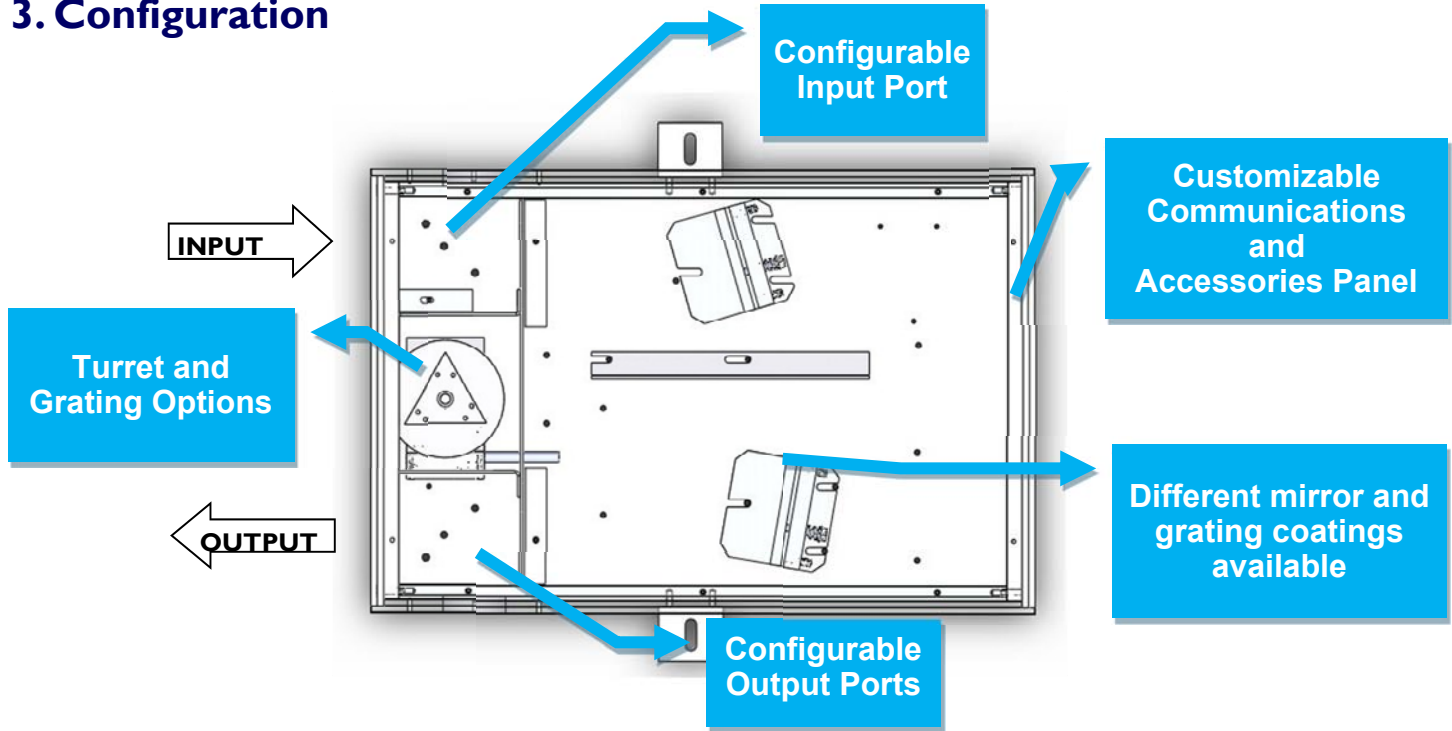

Step 1: Choose Chassis and F/#

Part #	Model	F/#	Focal Length	Turret Configuration
I20-9002	9010	F/3.5	200	Double Grating
I20-9001	9010F	F/2.6	200	Double Grating
I20-9018	9055	F/3.5	200/250	Triple Grating
I20-9023	9055F	F/2.5	200/250	Double Grating
I20-9008	9057	F/8	500	Triple Grating
I20-9042	9057F	F/5.9	500	Double Grating
I20-9017	9055DX	F/3.5	200/250	Triple Grating

Step 2: Choose Input Port Configuration

Part #	Model	Description
I20-8042	9000-ST-IN	Side input port
I20-8030	DPIN-ST-MAN	Dual input port
I20-8072	DPIN-ST-MOT	Motorized input port

Step 3: Choose Output Port Configuration

Part #	Model	Description
I20-8043	9000-ST-OUT	Side output port
I20-8031	DPOUT-ST-MAN	Dual output port
I20-8073	DPOUT-ST-MOT	Motorized output port

[Browse configuration options on Sciencetech's website!](#)



STANDARD SERIES MONOCHROMATORS

3. Configuration

Step 4: Grating Selection

There are three basic parameters to consider when choosing a grating for your standard series monochromator:

- **Required Wavelength Range**

The wavelength range available to you is determined by the grating groove density chosen and the angular mechanical limitation of the monochromator.

- **Grating Efficiency**

Ruled gratings may be blazed to increase their efficiency over a specific wavelength band. Holographic gratings can be modulated such that they are more efficient at some wavelengths than at others. Grating efficiency curves are the best tool for determining the most efficient grating available for your application. It is important to note that grating efficiency curves do not represent the exact efficiency that should be expected when the grating is used in a monochromator as grating efficiency curves are taken at Littrow angle.

- **Required Resolution and Bandwidth**

Resolution is a measure of an instrument's ability to separate adjacent spectral lines. Resolution is generally given in nm. The bandwidth (or bandpass) is the wavelength range that falls on the output port at any one time and is also given in nm. This is an important parameter when integrating a camera such as a linear array or CCD on the output port of the monochromator.

Turret and Grating Size	
Turret Configuration	Maximum Grating Size
Triple Turret	50 mm × 50 mm
Double Turret	64 mm × 64 mm

Application Note:

For Raman systems and when using a laser, ensure you choose a holographic grating.

Grating Selection Table for 200/250mm Focal Length Monochromators							
Grating (l / mm)	75	150	300	600	1200	1800	2400
Dispersion (nm/mm)	66.6	33.3	16.7	8.3	4	2.8	2.1
Resolution (nm)*	3.75	1.6	0.8	0.4	0.2	0.134	0.1
Bandwidth (nm)*	1650	840	420	210	105	73	52
Maximum Suggested** Wavelength (nm)	13900	6950	3475	1737	868	579	434
Maximum Realistic ** Wavelength (nm)	21891	10945	5472	2736	1368	912	684
Maximum Attainable ** Wavelength (nm)	25377	12688	6344	3172	1586	1057	793

* **Bandwidth** based on: Dispersion × 25.4mm wide array (important if using a LDA or CCD)

* **Resolution** based on: 50um wide input slit * Dispersion





** At the maximum suggested, realistic, and attainable wavelengths the approximate throughput corresponding to these wavelengths is >50%, ~15%, and ~0% of the maximum throughput, respectively.

STANDARD SERIES MONOCHROMATORS

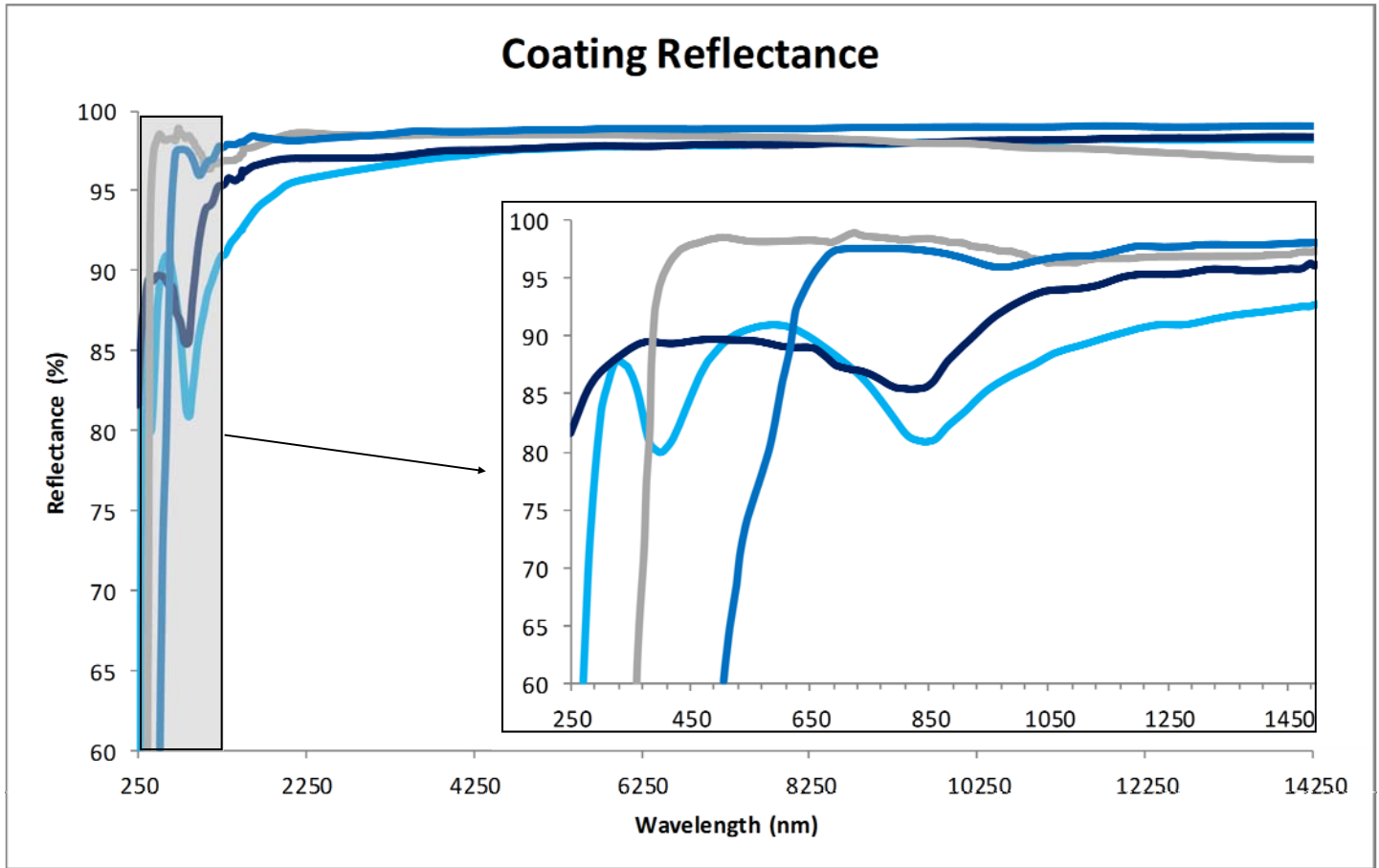
3. Configuration

Step 5: Mirror or Grating Coating



Mirror or Grating Coating		Useful Range	Code
Aluminum (MgF ₂)		350 nm+	-
UV-enhanced Aluminum		200 nm+	-UV
Silver		400 nm+	-S
Gold		600 nm+	-G

Standard mirror coatings are aluminum with a MgF₂ protective layer. Standard gratings have an aluminum coating. If your application would benefit from different mirror or grating coatings please refer to the codes above at the time of order.

[Browse gratings on Sciencetech's website!](#)

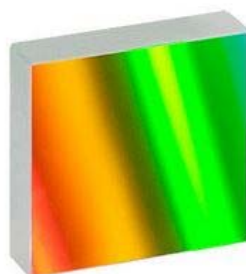

Need something you don't see here?

Sciencetech has built a reputation on custom solutions. Whether you need a small modification to an existing system, or a completely novel design built from the ground up to meet your technical specifications, Sciencetech's engineering and optical design teams are ready to help.



STANDARD SERIES MONOCHROMATORS

3. Configuration

Step 6: Imaging Option

Standard Czerny-Turner type monochromators suffer from astigmatism in the output beam due to the use of off-axis spherical mirrors. Often the astigmatism is not an issue. For imaging applications a toroidal mirror is used to compensate for the inherent astigmatism in the optical system produce a direct image of the input slit at the output port. This is an important option for studying phenomena such as fast kinetics.

Imaging Option	Note	Code
9055-i Monochromator	For 120-9018 Chassis only	120-9060
9057-i Monochromator	For 120-9008 Chassis only	120-9061
9055DX-i Double Monochromator	For 120-9017 Chassis only	120-9062

4. Accessories

Sciencetech manufactures and integrates a full line of input and output couplings as well as a selection of beam line connections. We offer a selection below, but visit our website to look at all the possibilities!

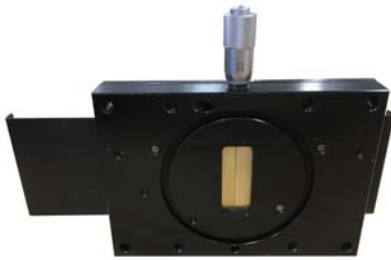

[Slit Assemblies](#)



[Adaptors and Connectors](#)



[Optical Choppers](#)



[Sample Chambers](#)



[Manual and Motorized Filter Wheels](#)



[Single Channel Detectors](#)



[Line and Area Detectors](#)



[Data Acquisition Equipment](#)



[Software](#)



STANDARD SERIES MONOCHROMATORS

5. Dimensions

Dimensions are in millimeters [inches].

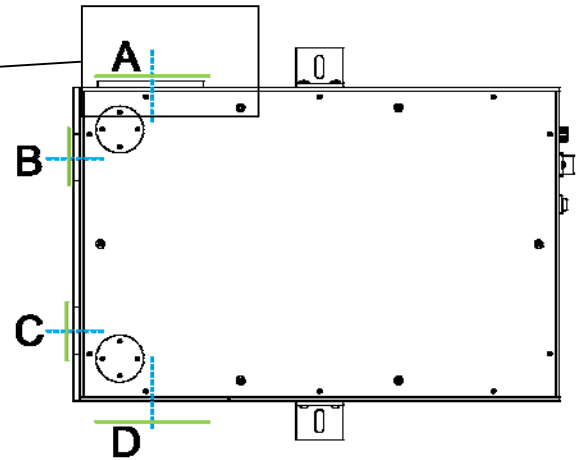
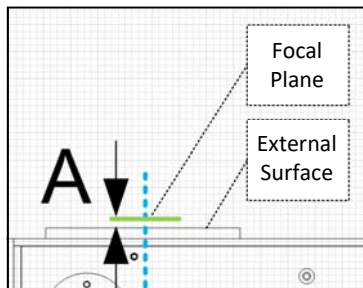
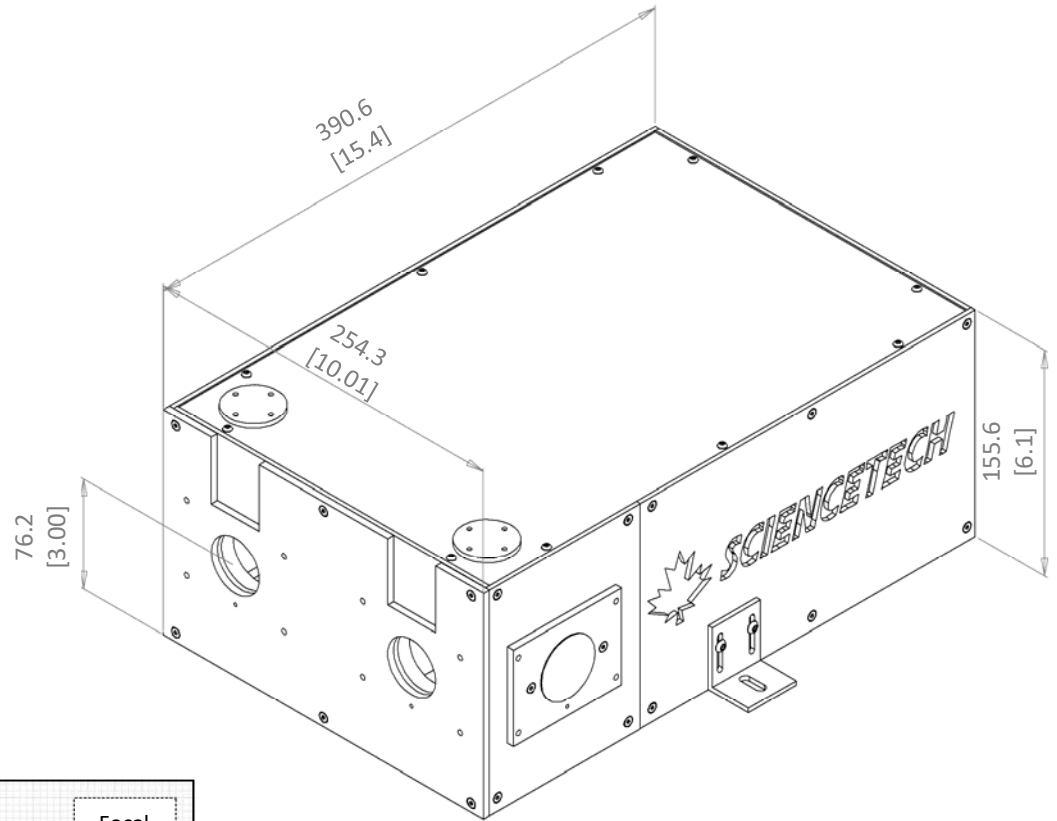

Location	Description	Nominal distance to focal plane (mm)	Maximum distance to focal plane (mm)	Maximum distance configuration
A	Side input port	3.2	7.9	Removal of spacer plate
B	Front input port	3.2	3.2	None
C	Front output port	3.2	3.2	None
D	Side output port	3.2	11.1	Removal of spacer and fascia plates